

HORSE CLUB™



schleich®

42533



+



**42533**



10152629 x 1



10152643 x 2



10152698 x 2



10152631 x 1



10152632 x 1



10152630 x 2



10134804 x 1



10152637 x 1



10152633 x 1



10160176 x 1



10160177 x 1



10152635 x 1



10133093 x 1



10117303 x 1



10153628 x 1



10133671 x 1



10133892 x 1



10154658 x 1



10155215 x 1



10154778 x 1

Änderungen vorbehalten / Subject to change without prior notice / Sous réserve de modification / Reservado el derecho a realizar cambios / Con riserva di modifiche

Contact us at [consumer@schleich-s.de](mailto:consumer@schleich-s.de) or [www.schleich-s.com/service](http://www.schleich-s.com/service).

1

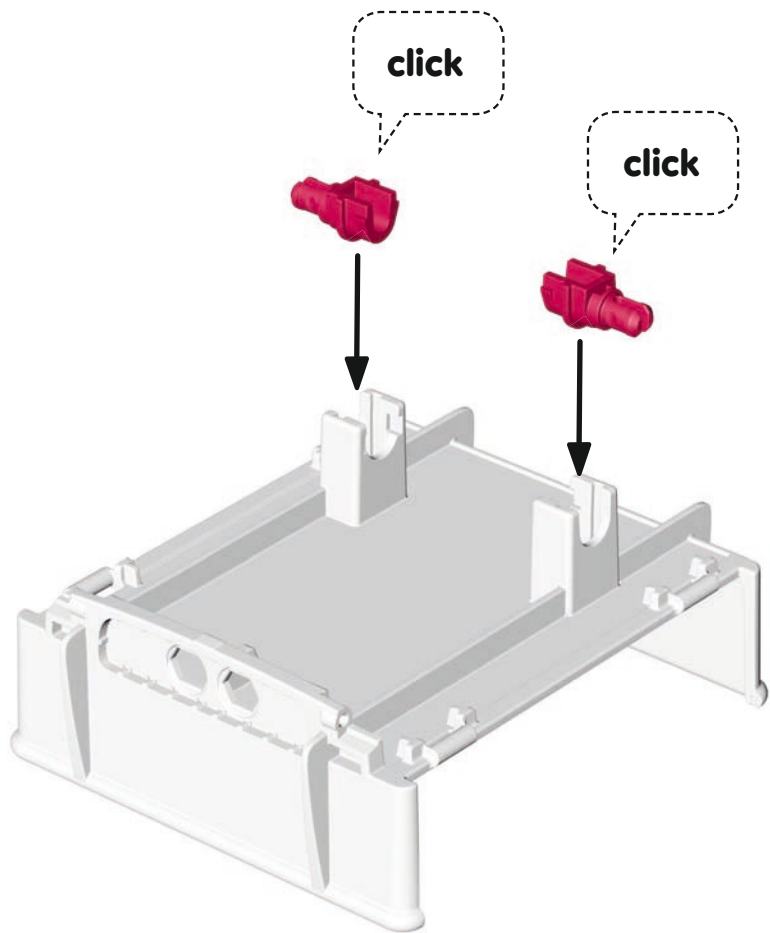

2

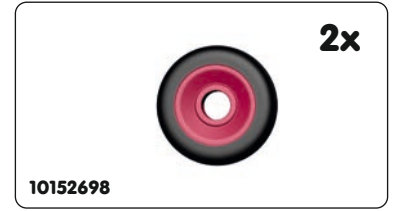
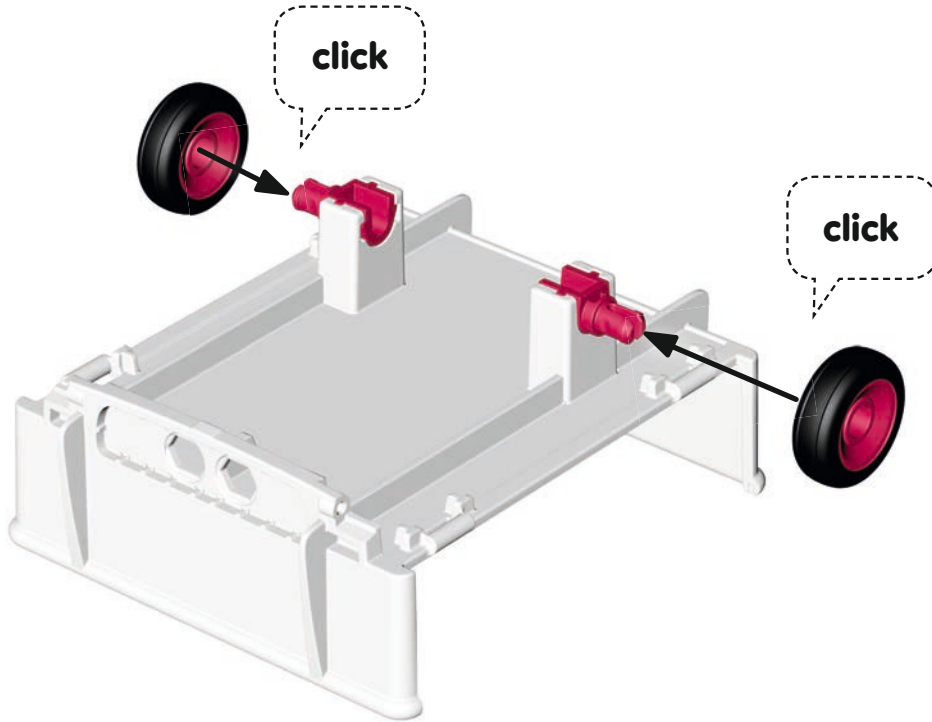

**3**

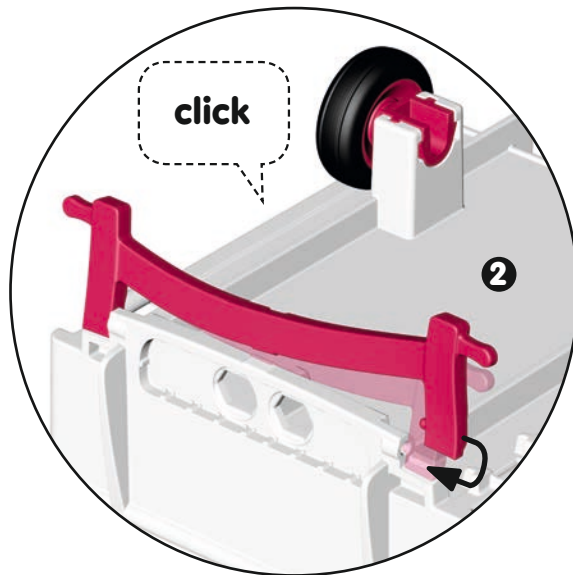
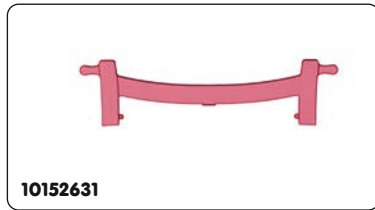
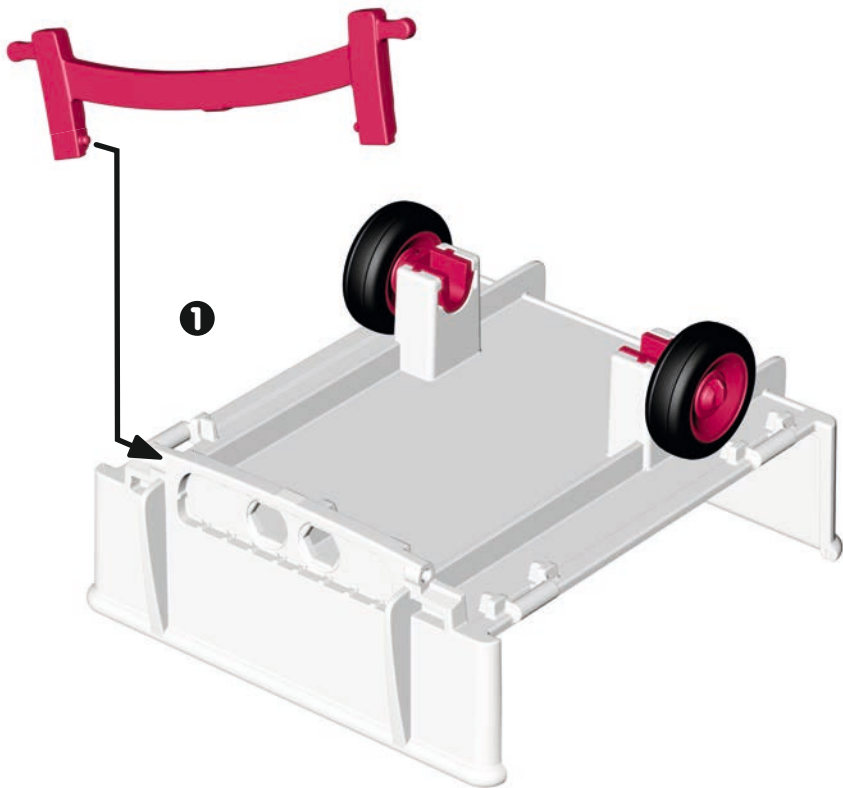

4

click

10152632

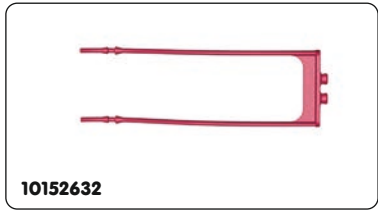
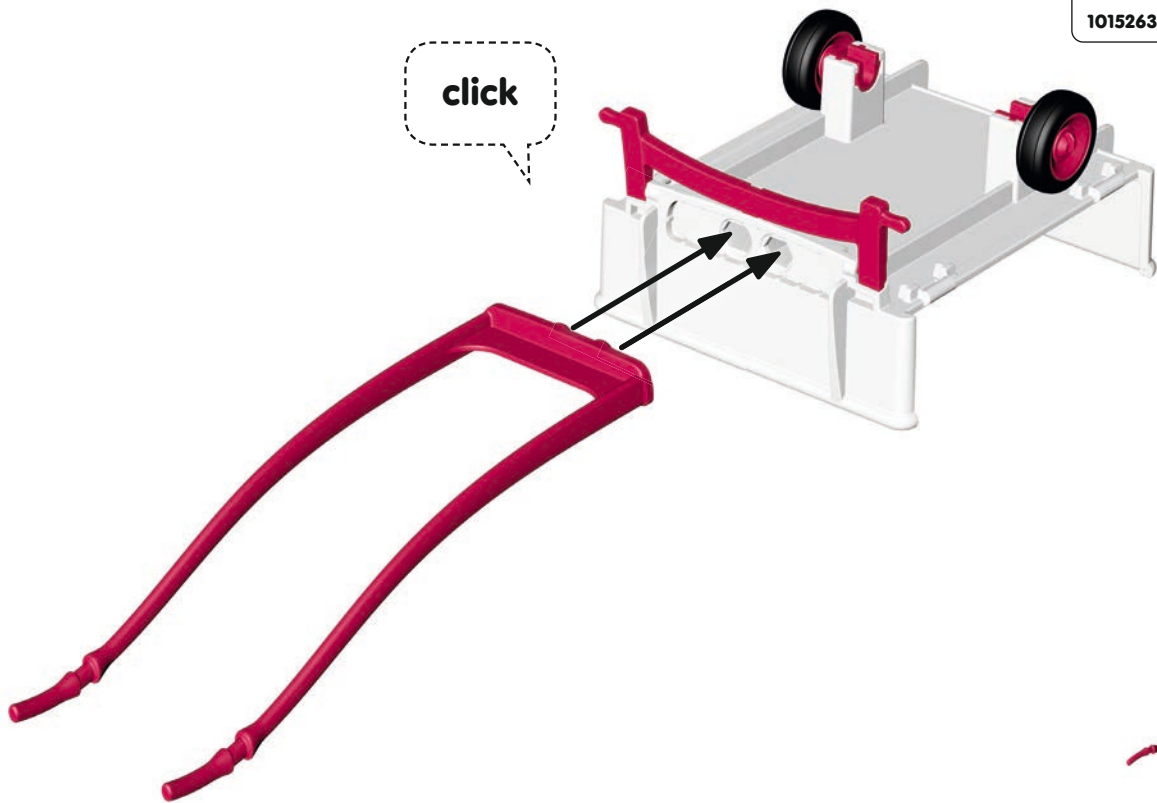

180°

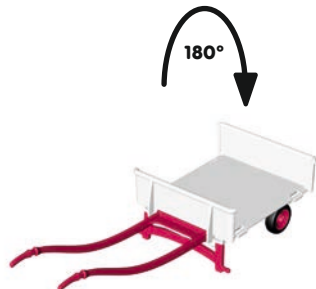

5

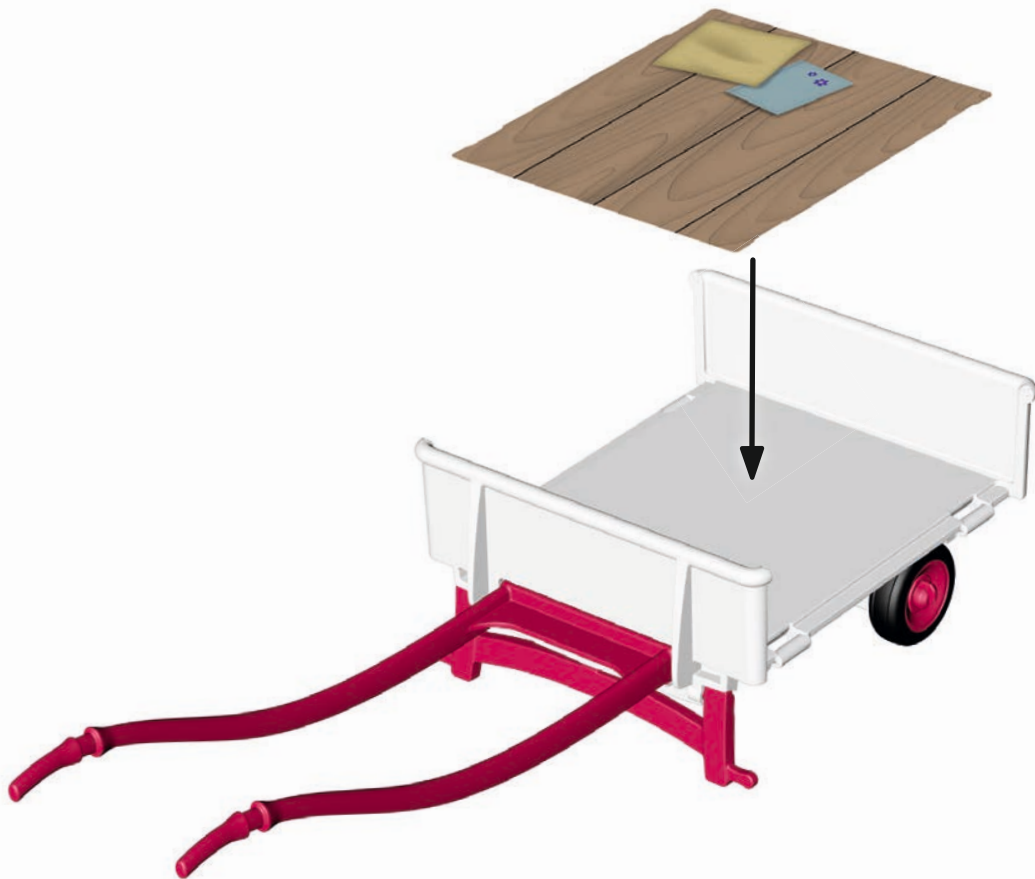

10160176

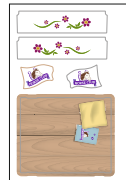

10160176

6

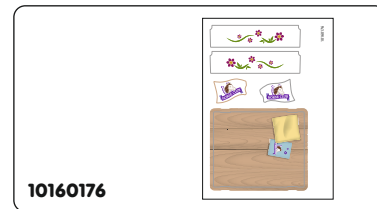
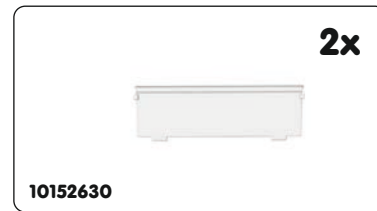
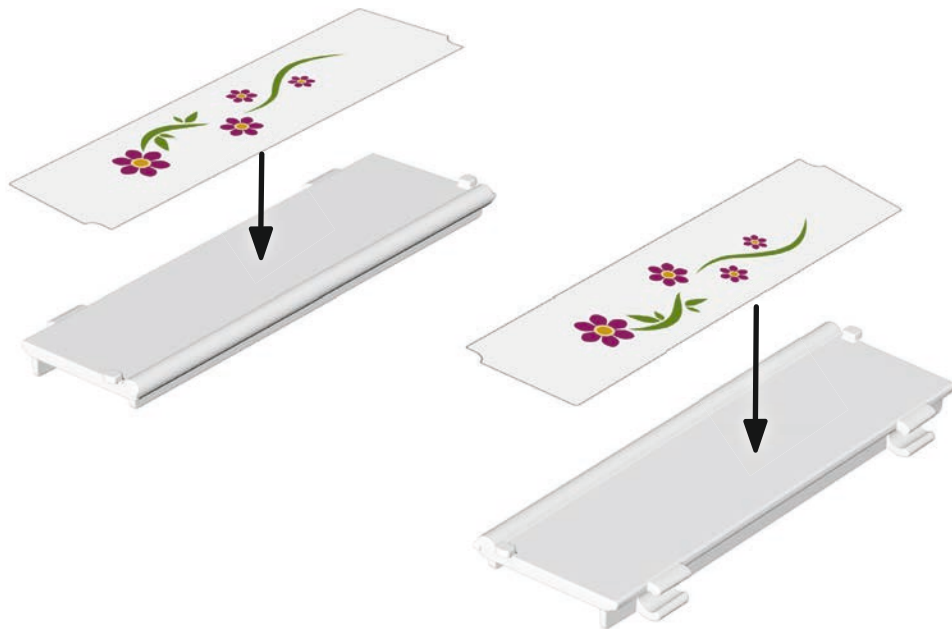



7

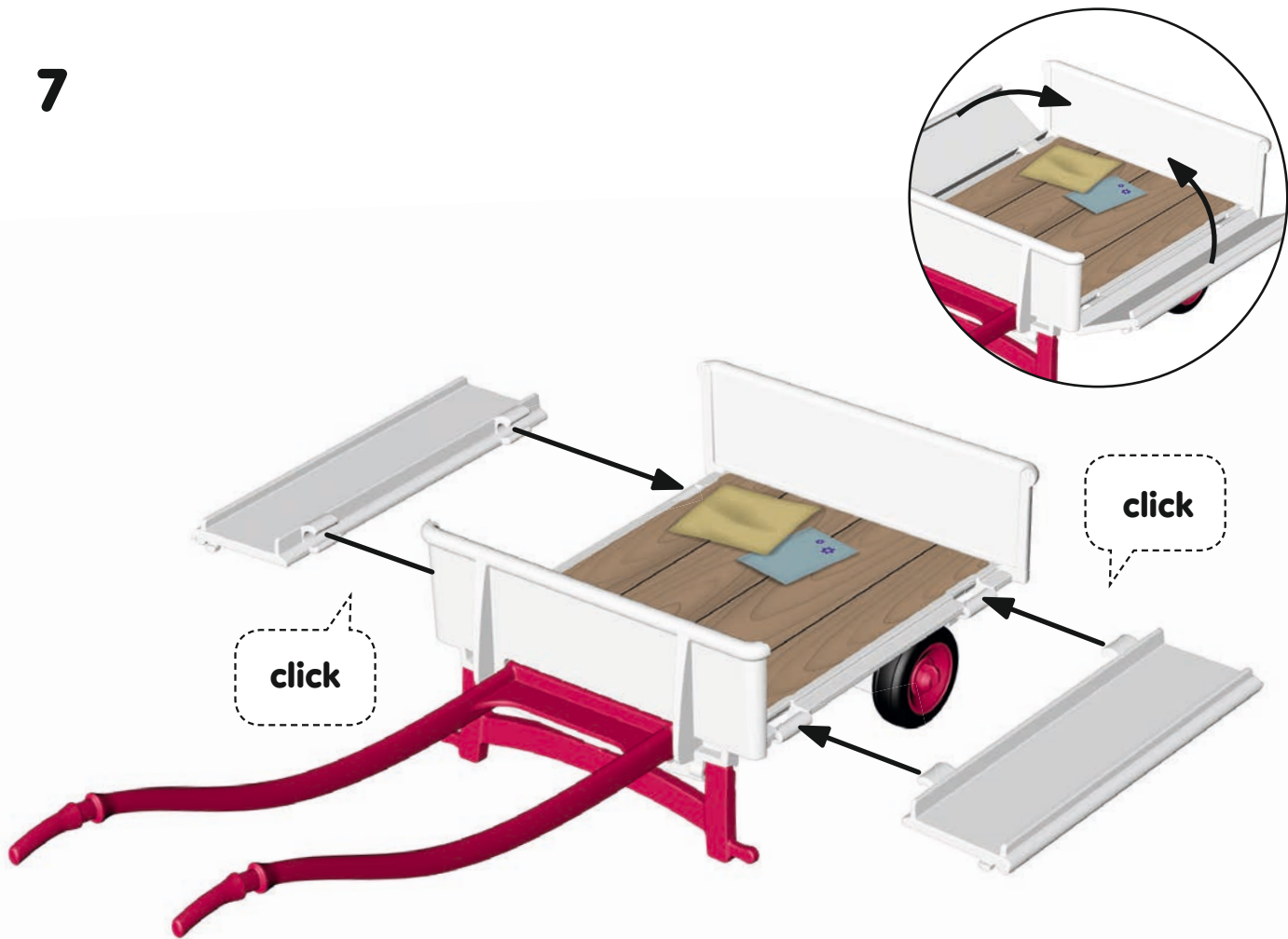

8

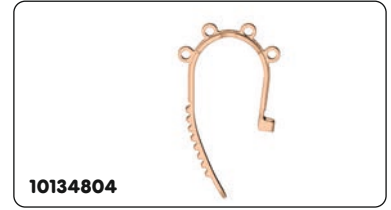
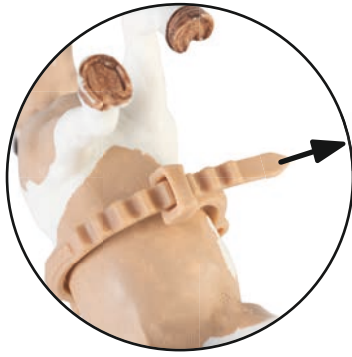
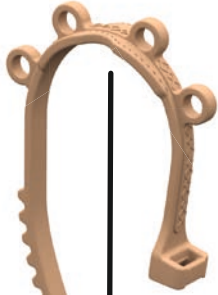

9

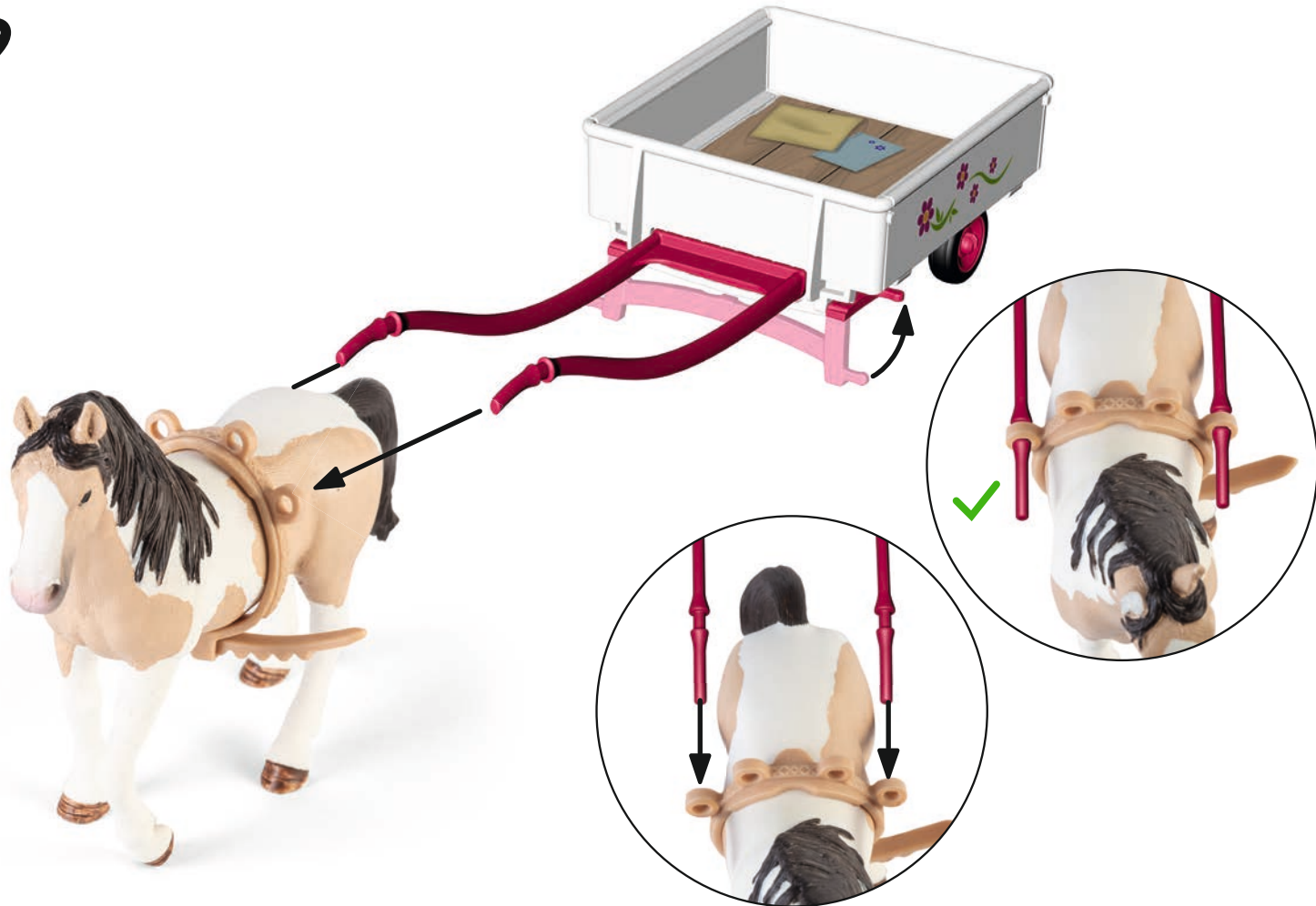

10



11

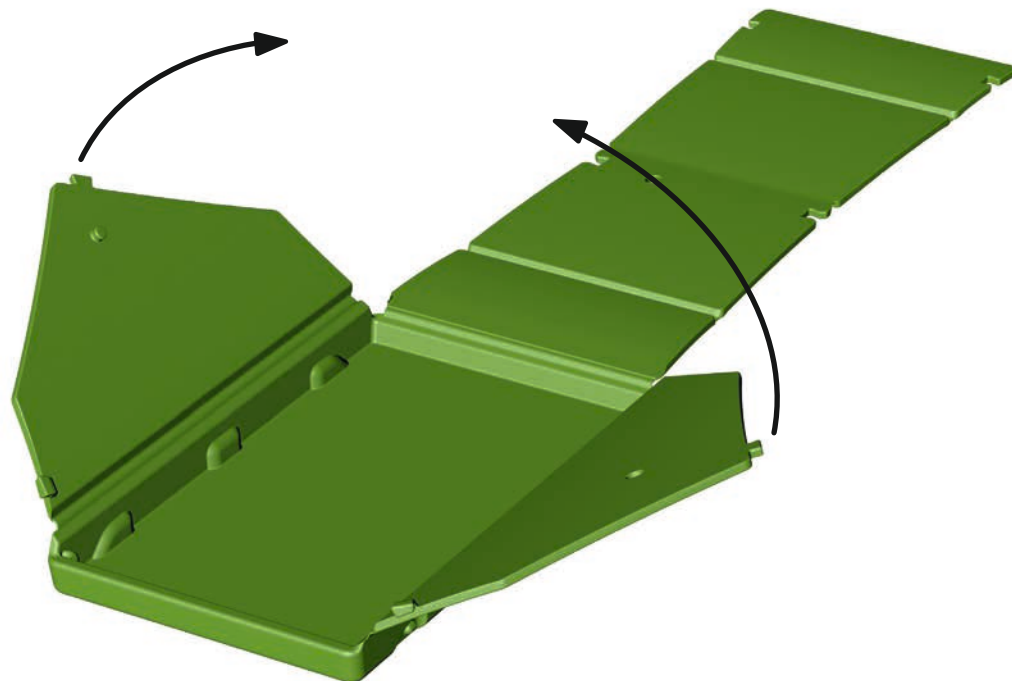
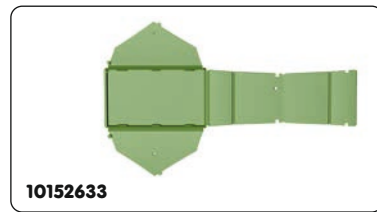

12

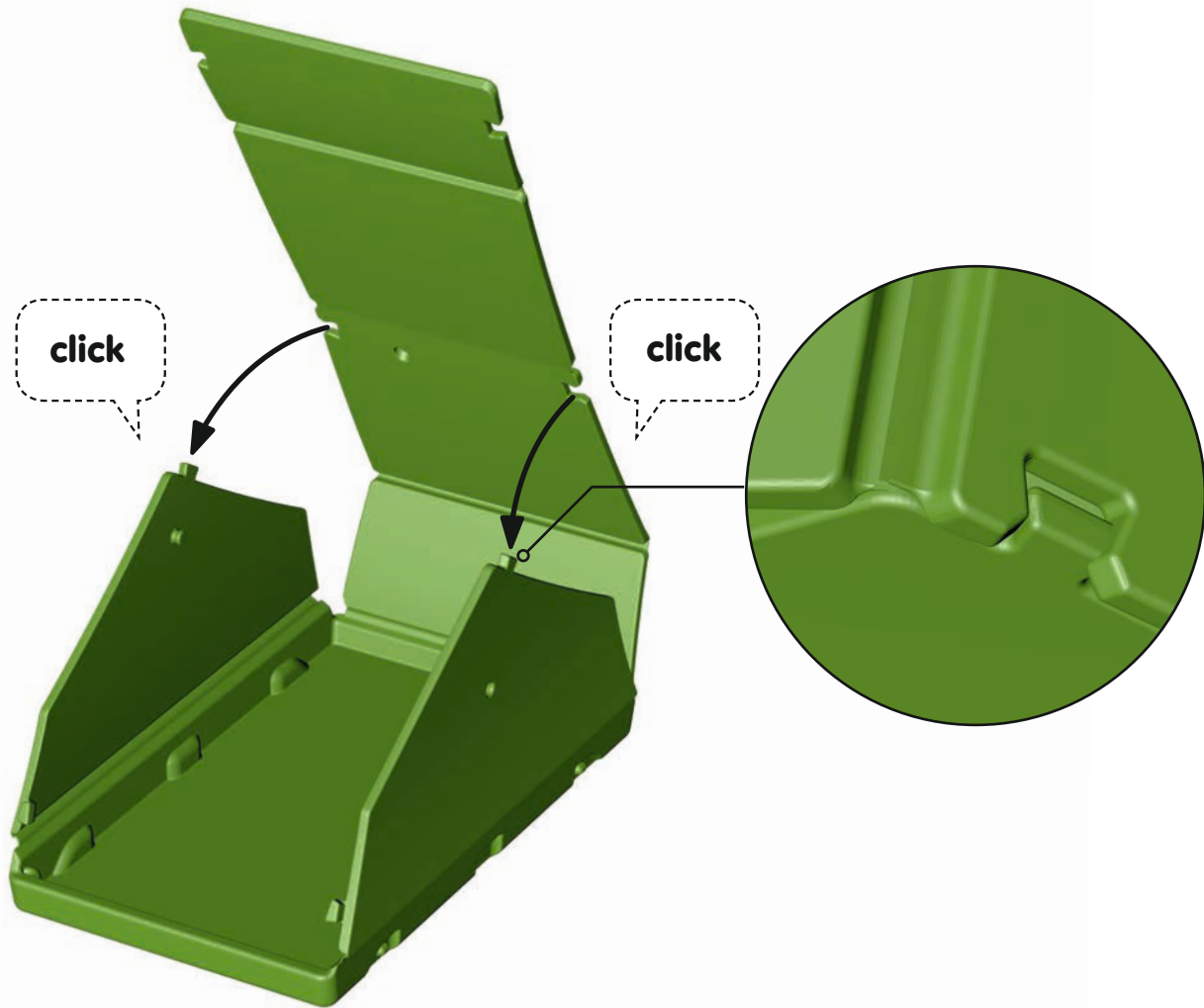

13

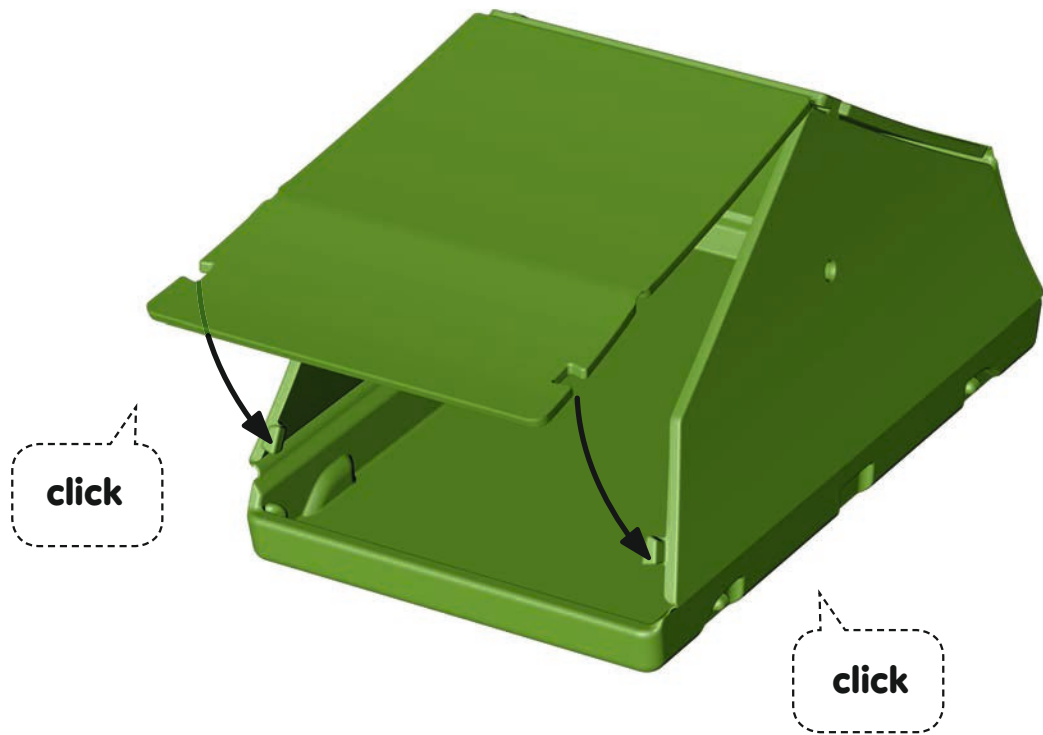

14

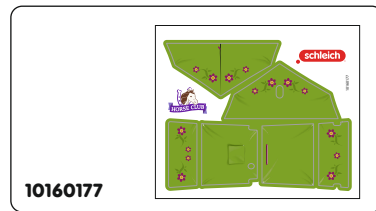

10160177



15

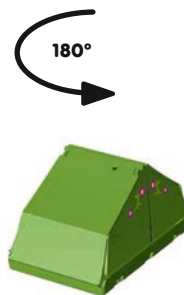
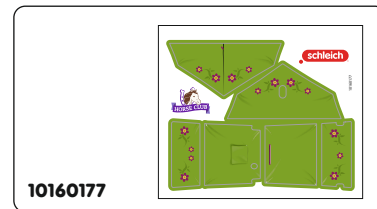
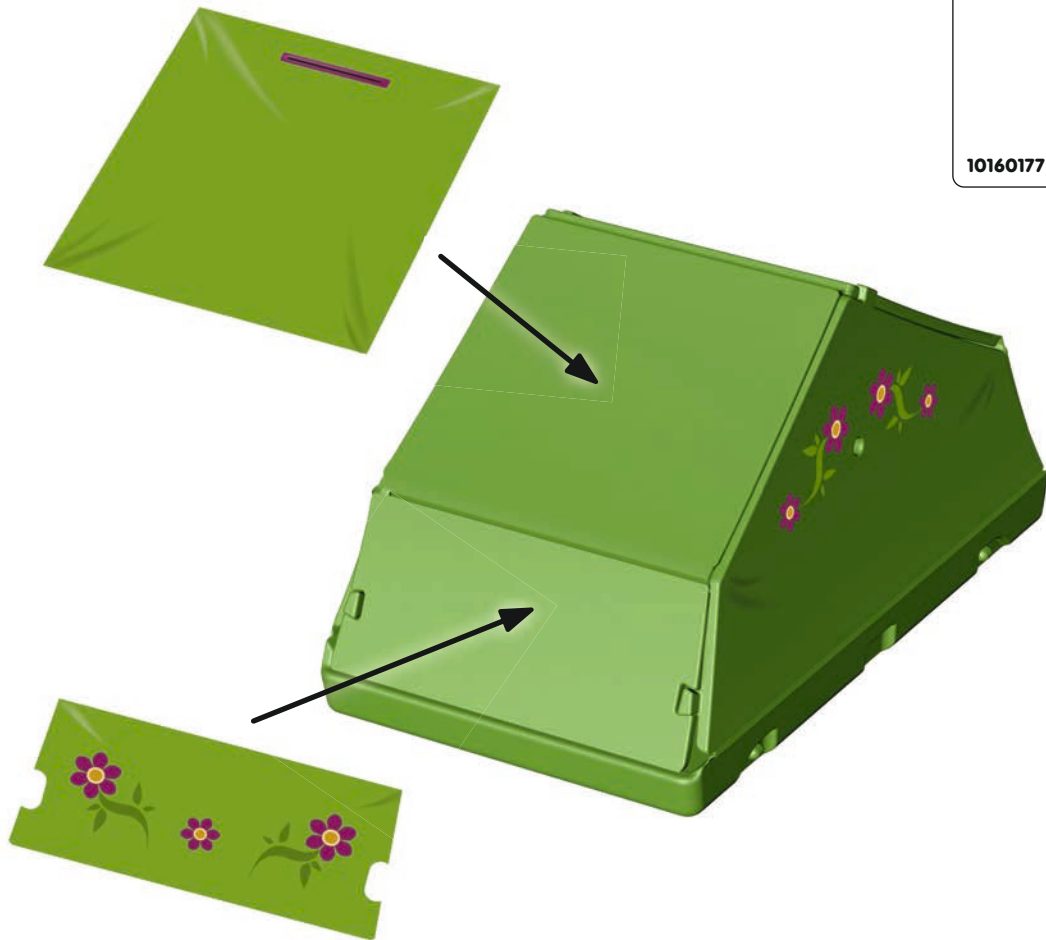

16

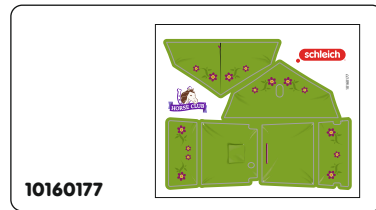
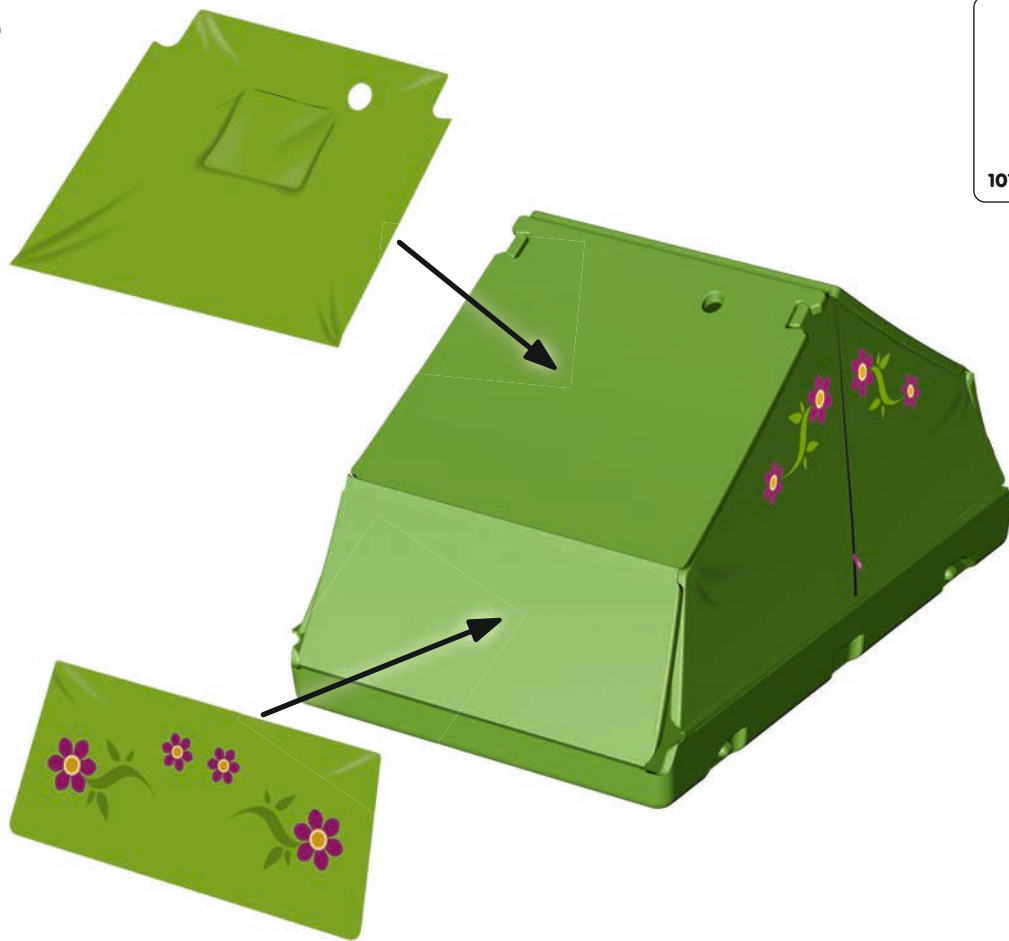

17

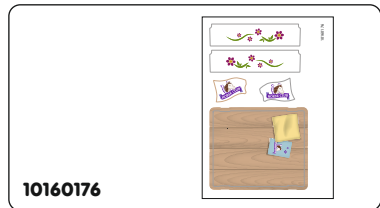
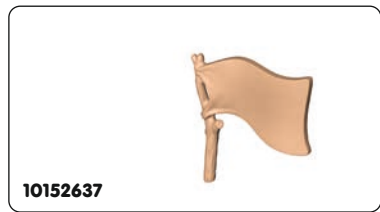
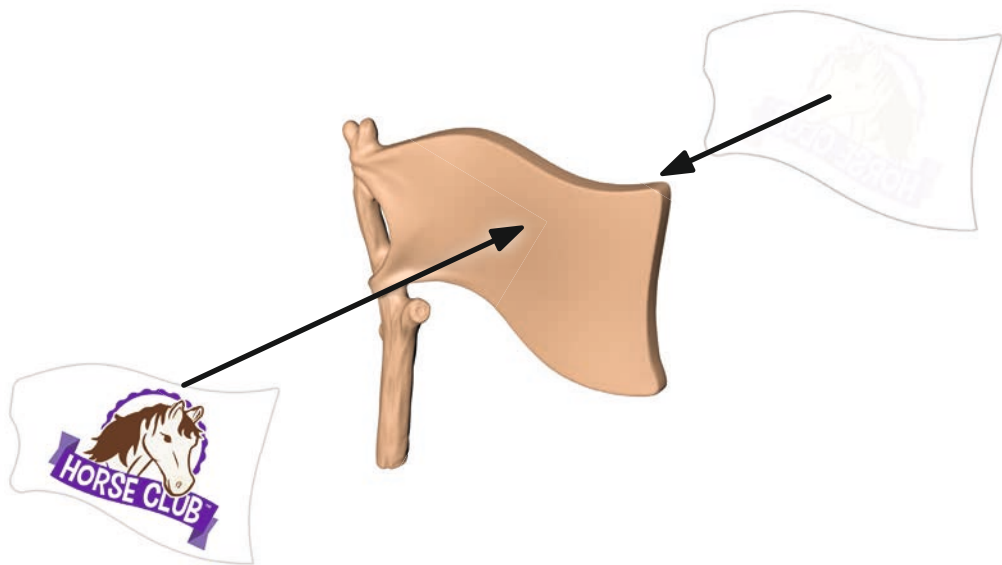

18



19



# 20

10155215



1



2



3







**schleich**



42551

42456

42592

[www.schleich-s.com/stories](http://www.schleich-s.com/stories)



Photo by Michael Wu

Addison, 12



Mandi, 11



Rosa, 9



YouTube

[www.schleich-s.com](http://www.schleich-s.com)